

Help line +44 1420 82377

**IT IS RECOMMENDED THAT LIGHTS ARE INSTALLED BY A QUALIFIED ELECTRICIAN**



Please read the instructions carefully before starting work and retain for future reference. Always turn off the mains supply at the consumer unit, shut off the Circuit breaker or remove the circuit fuse before commencing installation.

**Tools Required:** Flathead screwdriver, Phillips screwdriver, pliers, wire cutters, wire strippers, electrical tape, safety glasses.

**Estimated Assembly Time:** 25-30 minutes

**WARNING:**



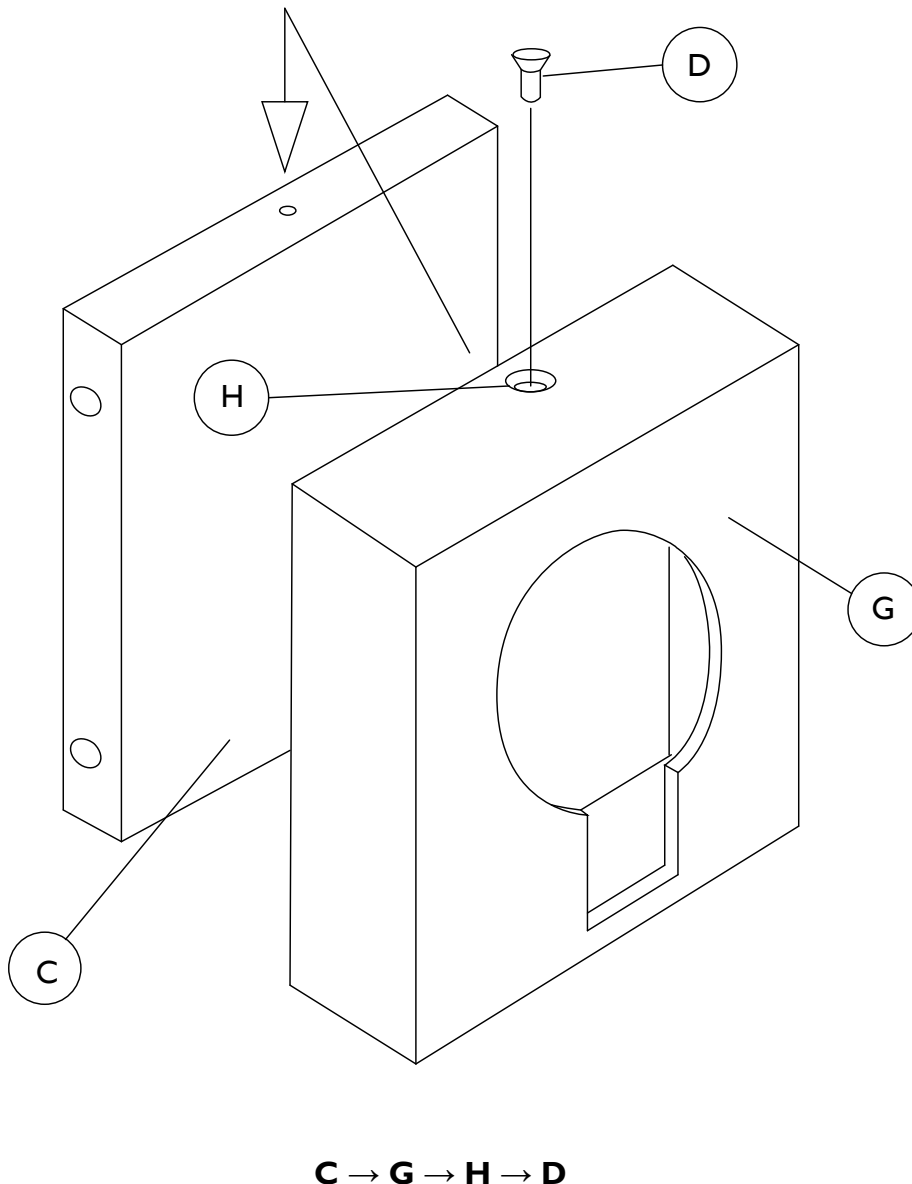



This fixture should only be installed by a qualified electrician.



1. Carefully unpack and identify all parts referring to illustration for parts identification.
2. Turn power to the installation point OFF.
3. Slipping outer body (G) over the mounted socket assembly (C) and align the top screw hole (H) with hole in top of socket assembly (C) and thread in screw (D) as shown in the diagram. Repeat process with bottom hole in outer body and socket assembly (C).
4. Referring to the installation instruction with the product for the wiring and installation.
5. Install proper bulbs (not provided) to each socket referring to the markings and / or labels on the fixture for maximum wattage.
6. Restore power to the installation point ON. Retain this sheet for future reference.



Before starting the electrical work or connecting your light you will need to switch off your power supply at the fuse box (consumer unit). Either the miniature circuit breaker (MCB) can be turned off for the circuit for your light and applying RED insulating tape over the MCB to prevent it from being accidentally turned on. Or the main switch can be turned off, the circuit fuse removed, and the main switch turned on again to restore power to the rest of the house.

GREEN/YELLOW	Earth	
BROWN	Live	
BLUE	Neutral	
BLUE with brown sleeving	Switch wire with sleeving	
Live wires can also sometimes be signified by a RED wire		
Neutral wires and also sometimes be signified by a white or black wire		

CLASS I Luminaires (Earthed) - Connect the brown wire from the luminaire to the supply live wire (red or brown). Connect the blue wire to the supply neutral wire (black or blue). Connect the green/yellow wire to the supply earth wire (green/yellow) or connect the supply earth to the luminaire earth terminal marked: 

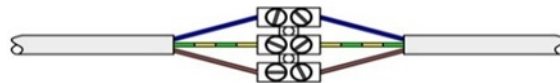

CLASS II Luminaires (Not earthed) - These luminaires are double insulated and have the symbol: 

These fittings do not have to be connected to the supply earth. Make sure that the basic insulation of the supply wiring cannot contact touchable metal. Connect the brown wire from the luminaire to the supply live wire (red or brown). Connect the blue wire to the supply neutral wire (black or blue). Isolate the supply earth wire.

If silicone sleeving is provided, fit over the supply cable up to the terminal block or lamp holder, to at least the mounting surface, to protect cable from heat.

