

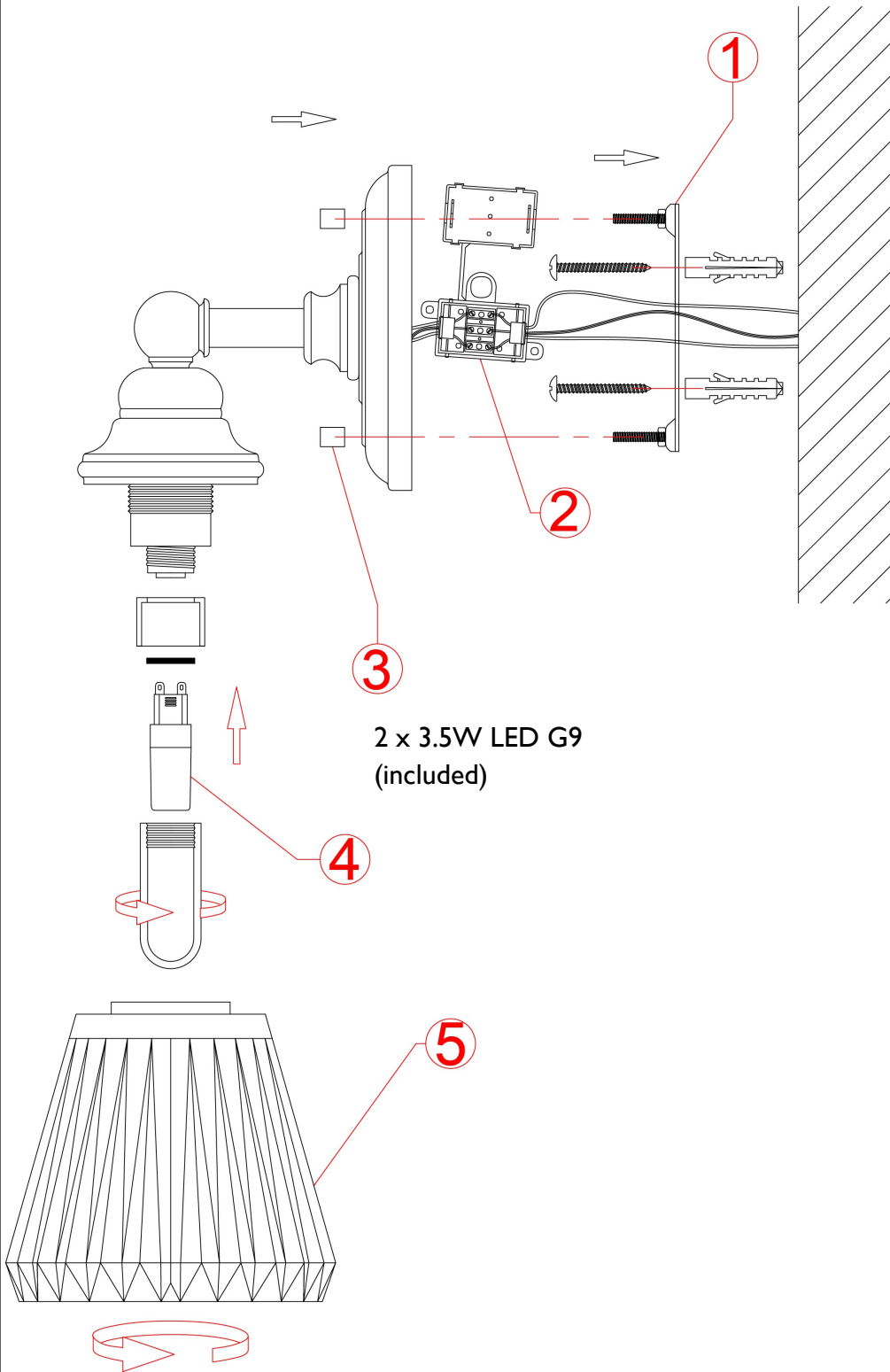







*Please install the fixture onto a sufficiently strong, load bearing surface*

See wiring instructions for electrical assistance

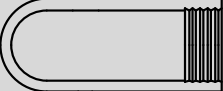
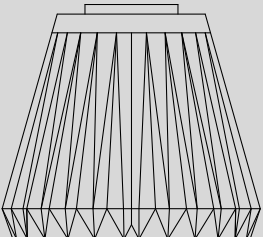
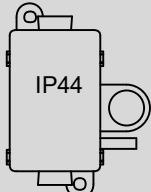

2 x 3.5W LED G9 (included)

-  x 2
-  x 2
-  x 1
-  x 2
-  x 2
-  x 2
-  x 2
-  x 2
-  x 2
-  x 1

Before starting the electrical work or connecting your light you will need to switch off your power supply at the fuse box (consumer unit). Either the miniature circuit breaker (MCB) can be turned off for the circuit for your light (it is suggested to apply **RED** insulating tape over the MCB to prevent it from being accidentally turned on). Or the main switch can be turned off, the circuit fuse removed, and the main switch turned on again to restore power to the rest of the house.

|                          |                           |   |
|--------------------------|---------------------------|---|
| GREEN/YELLOW             | Earth                     |  |
| BROWN                    | Live                      |  |
| BLUE                     | Neutral                   |  |
| BLUE with brown sleeving | Switch wire with sleeving |   |

Live wires can also sometimes be signified by a RED wire 

Neutral wires can also sometimes be signified by a white or black wire 

CLASS I Luminaires (Earthed) - Connect the brown wire from the luminaire to the supply live wire (red or brown). Connect the blue wire to the supply neutral wire (black or blue). Connect the green/yellow wire to the supply earth wire (green/yellow) or connect the supply earth to the luminaire earth terminal marked: 

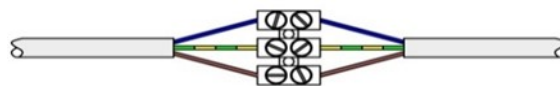

CLASS II Luminaires (Not earthed) - These luminaires are double insulated and have the symbol: 

These fittings do not have to be connected to the supply earth. Make sure that the basic insulation of the supply wiring cannot contact touchable metal. Connect the brown wire from the luminaire to the supply live wire (red or brown). Connect the blue wire to the supply neutral wire (black or blue). Isolate the supply earth wire.

If silicone sleeving is provided, fit over the supply cable up to the terminal block or lamp holder, to at least the mounting surface, to protect cable from heat.

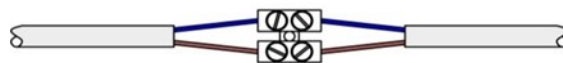

**Recycling**



Please try to recycle electrical products and components. Check with Local Authority or Retailer for recycling advice.